

SAFETY AND PRODUCTIVITY FOR YOUR EQUIPMENT



MAXI VISION®
CAMERA KITS
AND COMPONENTS
GUIDE



CONTENTS

CAMERAS	4
MONITORS	5
ACCESSORIES & CABLING	6
MOUNTING KITS & ENCLOSURES	7
MAXI VISION® RAM MOUNTING	8
DIGITAL VIDEO RECORDERS (DVR)	9
5" CAMERA KITS	10
7" CAMERA KITS	11
10.4" CAMERA KITS	12
15" CAMERA KITS	13
27" CAMERA KITS	13
DVR CAMERA KITS	14
FORKLIFT CAMERA SYSTEMS	16
CAMERA SYSTEM TYPICAL LAYOUTS	17
CAMERA SYSTEM WITH DVR TYPICAL LAYOUTS	18

CAMERAS

The Maxi Vision® range of cameras have been specifically designed to suit the harshest of environments.



Part No 14220

BALL CAMERA IP69K HEAVY DUTY

The 14220 camera features the latest Sony CMOS technology housed in a rugged, IP69K, die-cast assembly, making this camera one of the leading vision components available.

Compact in design and lightweight, this camera reduces the amount of machine space required for fitment while providing crystal-clear imagery.

FEATURES

- Sony ISX017 WDR Sensor Colour CMOS
- High Resolution 1000 TV Lines
- Low Illumination
- Rated to IP69K
- In-built Power Status LED
- On-screen Activity Indicator

SPECIFICATIONS

Dimensions:	Height: 70mm (2.7") Depth: 53mm (2") (with bracket)
Weight:	120g (0.2lbs) (without bracket)
Temperature Range:	Operating: -20°C ~ 60°C (-4°F to 140°F)
Angle of Vision:	82(H) x 61(V) x 104(D)
Total Pixels:	1,297(H) x 977(V) 1.27M
Min Illumination:	0.1Lux (F=2.0)
Input Voltage:	12 / 24 V DC



Part No 11858

COLOUR CAMERA IP68 CCD HAD II (SMALL)

- Operating temperature: -20°C to 65°C (-4°F to 149°F)
- Lens: F 2.0/30 IRE
- Minimum illumination: 0.5 Lux
- Input voltage: 12 V DC
- Dimensions: 36.6(W) x 27(H) x 37.7(D) mm (1.4" x 1" x 1.5")
- Weight: 80g (0.17lbs)
- Aluminium die-cast waterproof housing
- Complete with 20m (65.6ft) loom
- Waterproof microphone



Part No 0683

BLACK AND WHITE CAMERA 110°

- Operating temperature: -10°C to 55°C (14°F to 131°F)
- Lens: F 2.0 110°
- Minimum illumination: 1 Lux
- Input voltage: 12 V DC
- Dimensions: 70(W) x 44(H) x 57(D) mm (2.7" x 1.7" x 2.2")
- Weight: 300g (0.66lbs) including bracket
- Aluminium die-cast waterproof housing
- Waterproof microphone
- Complete with 20m (65.6ft) loom



Part No 11857

COLOUR CAMERA IP69 CCD HAD II

- Operating temperature: -20°C to 60°C (-4°F to 140°F)
- Lens: F 2.0 110°
- Minimum illumination: 0.1 Lux
- Input voltage: 12 V DC
- Dimensions: 70(W) x 44(H) x 57(D) mm (2.7" x 1.7" x 2.2")
- Weight: 400g (0.88lbs) including bracket
- Aluminium die-cast waterproof housing
- Complete with 20m (65.6ft) loom



Part No 11846

COLOUR CAMERA INFRA-RED 110DEG

- IR LED Capabilities: Visible IR LED (850nm) x6
- Input voltage: 12 V DC
- Dimensions: 70(W) x 44(H) x 57(D) mm (2.7" x 1.7" x 2.2")
- Weight: 400g (0.88lbs) (with bracket)
- IP67
- Built-in audio



Part No 14348

DUAL VIEW CAMERA A TYPE

- Operating temperature: -20°C to 60°C (-4°F to 140°F)
- View Angle: Drive: 80(H) x 60(V) x 95(D)
Rear: 120(H) x 90(V) x 140(D)
- Minimum illumination: 0.2 Lux (F=2.4)
- Input voltage: 12/24 V DC
- Dimensions: 28(W) x 33(D) mm (1.1" x 1.3")
- Weight: 44.5g (0.1lbs)
- IP68 metal housing

MONITORS



Part No **9299**

5" WATERPROOF MONITOR COLOUR TFT IP67 HEAVY DUTY

- Reverse polarity protected
- 3 camera input (NTSC/PAL)
- Full screen picture display
- Complete with heavy duty mounting, sun visor and all cabling
- 3 standby wire function
- 2.5m (8.2ft) sealed connection lead
- Manual dimmer function inbuilt (day/night function)
- 12/24 V DC
- IP67 rated



Part No **11939**

7" WATERPROOF MONITOR COLOUR TFT IP67 HEAVY DUTY

- Reverse polarity protected
- 7 different screen layouts
- 1, 2, 3 and 4 split screen
- Complete with heavy duty mounting, sun visor and all cabling
- 4 standby wire function
- 2.5m (8.2ft) sealed connection lead
- Auto dim function for easy viewing in changing light conditions
- Internal mirror image settings
- Easy to navigate menus via on screen display (OSD)
- 12/24 V DC
- IP67 rated



Part No **11926**

7" MONITOR COLOUR TFT IN CAB

- Split connections for easy installation
- Auto dim function for easy viewing in changing light conditions
- Lightweight and durable for easy handling and longer use
- Touch screen control for ease of use, also includes remote control
- 12/24 V DC



Part No **11935**

10.4" MONITOR 12V COLOUR TFT METAL CASE

- 12 V DC
- Power consumption: 9.6W
- LCD: 10.4" colour TFT LCD
- Operating temperature: -10°C to 50°C (14°F to 122°F)
- Dimensions: 254(W) x 202(H) x 29(D) mm (10" x 7.9" x 1.1")
- Weight: 1.5kg (3.3lbs)
- Card type IR remote control
- Auto TV system (NTSC, PAL, AUTO)
- 0.5 W speaker @ 12V



Part No **14338**

10" WATERPROOF MONITOR 12/24V COLOUR IP67 HEAVY DUTY

- 1, 2, 3 and 4 split screen
- Comes with heavy duty mounting
- Stand-by wire function
- Internal mirror image settings
- Auto dim function for easy viewing in changing light conditions
- Easy to navigate menus via on screen display (OSD)
- Operating temperature: -20°C to 60°C (-4°F to 140°F)
- Dimensions: 263(W) x 183(H) x 29(D) mm (10.3" x 7.2" x 1.1")
- Weight: 877g (1.9lbs)
- NTSC, PAL, AUTO
- 0.5 W speaker



Part No **5670**

TELEVISION 7" 12V TFT

- 7" TFT LCD TV
- On Screen Display (OSD)
- 0.5 W speaker installed
- TV/AV/camera selection function
- Card type IR remote control
- Fast channel search and auto memory
- Wide range of channels (CH2-CH69)
- External antenna input
- External AV input and multiple connection
- Camera connection terminal
- Low energy consuming rate (Max power: 950mA @ 12V)



Part No **12891**

15" MONITOR 12V COLOUR LCD

- 15" TFT LCD monitor
- On Screen Display (OSD)
- 0.5 W speaker installed
- IR remote control
- External antenna input
- External AV input and multiple connection
- Low energy consuming rate (Max power: 950mA @ 12V)
- 12 V DC
- Dimensions: 381(W) x 299(H) x 46(D)mm (15" x 11.7" x 1.8")
- Weight: 3.5kg (7.7lbs)
- Pixels: 1024 x 768



Part No **12772**

27" MONITOR 12V COLOUR TFT

- 27" TFT LCD monitor
- On Screen Display (OSD)
- 0.5 W speaker installed
- Inputs: AV, HDMI, VGA, PC stereo
- Power consumption: <30W
- 12 V DC
- Dimensions: 648.5 x 401 x 68mm (25.5" x 15.7" x 2.6")
- Weight: 7kg (15.4lbs)
- Pixels: 1920 x 1080

ACCESSORIES & CABLING

The Maxi Vision® looms and adaptors have been designed to integrate the Maxi Vision® range with current machine infrastructure.



Part No **6838**

QUAD SPLITTER BOX 4 CAMERA INPUT

The Maxi Vision® Quad Splitter has been specifically designed to integrate multiple cameras into any Maxi Vision® monitor.

Including four trigger line inputs, this unit can display 1/2/3/or 4 images on screen at the same time.

FEATURES

- Voltage in: 12 - 24 V DC Voltage out: 12V DC 1A
- Power consumption: 200mA
- 140(W) x 30(H) x 90(D) mm (5.5" x 1.1" x 3.5")
- -10°C to 60°C (14°F to 140°F)
- 380g (0.8lbs)
- Wireless remote control
- 4 camera input, multi-screen display
- Reverse wire auto-on function on all camera inputs



Part No **11927**

1 CAMERA INPUT LOOM TO SUIT 11939 MONITOR



Part No **11928**

2 CAMERA INPUT LOOM TO SUIT 11939 MONITOR



Part No **11929**

3 CAMERA INPUT LOOM TO SUIT 11939 MONITOR



Part No **11930**

4 CAMERA INPUT LOOM TO SUIT 11939 MONITOR



Part No **3876**

REDUCER REGULATOR

- Regulates power input to absorb machine spike voltage
- Set incoming voltages 9 to 32 V DC
- Output: 12 V 3 Amp



Part No **2951**

ADAPTOR KIT (MINI DIN TO DEUTSCH PLUG)

- Heavy duty four core harness
- Cable length 400mm (15.7")



Part No **4946**

ADAPTOR LOOM TO SUIT 11586 / 14220 CAMERA



Part No **1346**

EXTENSION LOOM 15FT / 5M TO SUIT 11857 / 0683 CAMERA



Part No **5593**

EXTENSION LOOM 70FT / 20M TO SUIT 11857 / 0683 CAMERA



Part No **6450**

EXTENSION LOOM 7M TO SUIT 11858 CAMERA



Part No **8093**

ADAPTOR LOOM MINI DIN TO RCA INPUT



Part No **11373**

ADAPTOR LOOM TO SUIT 10895 DVR SYSTEM



Part No **2880**

ADAPTOR LOOM RCA MALE TO RCA MALE 1M



Part No **12526**

ADAPTOR KIT TO SUIT MINI JACK (SCREW TYPE) TO DEUTSCH

MOUNTING KITS & ENCLOSURES

The Maxi Vision® range of mounting kits and enclosures has been designed to integrate with current machine infrastructure.

These specific mounting options have been manufactured to allow Maxi Vision® systems to be mounted in different applications and positions in and around the cab.



Part No **10974**

**MOUNTING KIT TO SUIT 7205
MONITOR (RAM MOUNT)**



Part No **1756**

**ENCLOSURE TO SUIT 0683 / 11857
CAMERA**



Part No **8420**

**MOUNTING KIT TO SUIT 9299
MONITOR LIGHT DUTY**



Part No **8421**

**MOUNTING KIT TO SUIT 11939
MONITOR LIGHT DUTY**





































Part No **8795**

**MOUNTING KIT TO SUIT 11939 / 9299
MONITOR (RAM MOUNT)**

MAXI VISION® RAM MOUNTING

Maxi Vision® systems have a RAM mounting solution to suit most applications.

	 8464 RAM Double Socket Arm 1 3/4"	 8460 RAM Double socket Arm 3"	 8799 RAM Double Socket Arm 6"
 8795 RAM Base Kit to suit Maxi Vision 5" & 7" Monitors	 8795 + 8464	 8795 + 8460	 8795 + 8799
 8494 RAM Base Double U-Bolt for Rails to 1.25" in Diameter	 8494 + 8464	 8494 + 8460	 8494 + 8799
 9292 RAM Base 3" Clamp	 9292 + 8464	 9292 + 8460	 9292 + 8799
 8455 RAM Base 1/4"-20 UNC Female Thread with Hex	 8455 + 8464	 8455 + 8460	 8455 + 8799
 8493 RAM Base 2" x 3" Universal Rectangular	 8493 + 8464	 8493 + 8460	 8493 + 8799
 8798 RAM Base 2" x 6" Universal Rectangular	 8798 + 8464	 8798 + 8460	 8798 + 8799
 8492 RAM Base 2.5" Diameter Round	 8492 + 8464	 8492 + 8460	 8492 + 8799
 15475 RAM Base Diamond	 15475 + 8464	 15475 + 8460	 15475 + 8799

DIGITAL VIDEO RECORDERS (DVR)



Part No **14318**

RECORDER DVR 4CH SSD 12/24V

The robust Maxi Vision® Digital Video Recorder (DVR) is housed in an aluminium casing to withstand the harshest of environments.

This multi-voltage unit comes complete with heavy-duty Solid State Drive (SSD), GPS Antenna, Remote Control and four camera inputs.

All recorded images can be viewed on screen (four camera views with GPS co-ordinates and speed indicator displayed).

Images are easily downloaded by the Maxi Vision® PC Viewer showing over speed, events, driving route, speed, time, location and GPS tracking via Google map interface (Terrain or Map display available).

FEATURES

- 4 Camera input
- 4 split screen functions inbuilt with play back via PC viewer enabling 1, 2, 3, 4 split screen playback
- GPS enabled
- Multi voltage 12/24 V unit
- Easy to navigate and download PC viewer
- Quick change SSD recording

SPECIFICATIONS

Dimensions:	Width: 129.5mm (5") Length: 166.5mm (6.5") Depth: 42.5mm (1.6")
Weight:	586g (1.3lbs)
Temperature Range:	Operating: -10°C to 60°C (14°F to 140°F) Storage: -30°C to 70°C (-22°F to 158°F)
Compression:	H.264/AVI
Memory:	SSD (Min.128GB ~ max.1TB)
Recording:	1920 x 960 or 960H (960 x 480) @30fps
Input Voltage:	12 / 24 V DC



Part No **13542**

DVR COMPACT RECORDER 2 CAMERA

The all-in-one unit solution for driver management, events recording, machine monitoring and training.

The Compact DVR Recorder has been designed to assist with in-cab and forward monitoring on mobile equipment.

This multi-voltage unit comes complete with in-built forward and reverse cameras, SD card, GPS and G-shock sensors.

Images are easily downloaded by the Maxi Vision® PC Viewer showing over speed, events, driving route, speed, time, location and GPS tracking via Google map interface (Terrain or Map display available).

SPECIFICATIONS

Dimensions:	Width: 105mm (4.1") Height: 22mm (0.8") Depth: 67mm (2.6")
Weight:	156g (0.34lbs) including bracket
Temperature Range:	Operating: -10°C to 60°C (14°F to 140°F)
Compression:	H.264/AVI
Memory:	SD Card (max.64GB)
Resolution:	Inside : VGA (640x480) / Outside : HD (1280x720)
Frame:	30fps x 2 (Parking : 1fps)
Mode:	Ordinary / Event (Motion / G-sensor)
Time	Ordinary : Recording at intervals of 2 min. / Event: 10 seconds prior, 20 second
GPS:	Internal (5 step)
G-sensor:	Internal
Current:	350mA @12VDC
Input Voltage:	12 - 24 V DC (with super cap) @max.32V



Part No **14320**

SSD DRIVE ASSEMBLY TO SUIT 14318 256G

- 256G Solid state drive
- Minimum 4 days,24 hour recording
- Hot swap capable



Part No **10920**

SPARE GPS ANTENNA TO SUIT 14318



Part No **10898**

SPARE KEY SET TO SUIT 14318

5" CAMERA KITS

The Maxi Vision® camera range offers operators a new perspective when operating their equipment - enhancing safety and productivity.

5" BLACK & WHITE CAMERA KIT - STANDARD CAMERA



3624 pictured

- 1 x Camera kit - **Part No 3630**
- 2 x Camera kit - **Part No 3628**
- 3 x Camera kit - **Part No 3624**

Kit includes:

1	9299	5" MONITOR LCD
1-3	0683	BLACK & WHITE CAMERA
1	3876	RED/REG 9-32V IN 12V 2A OUT

5" COLOUR CAMERA KIT - STANDARD CAMERA



3617 pictured

- 1 x Camera kit - **Part No 3648**
- 2 x Camera kit - **Part No 3638**
- 3 x Camera kit - **Part No 3617**

Kit includes:

1	9299	5" MONITOR LCD
1-3	11857	COLOUR CAMERA
1	3876	RED/REG 9-32V IN 12V 2A OUT

5" COLOUR CAMERA KIT - HEAVY DUTY CAMERA



11690 pictured

- 1 x Camera kit - **Part No 11688**
- 2 x Camera kit - **Part No 11689**
- 3 x Camera kit - **Part No 11690**

Kit includes:

1	9299	5" MONITOR LCD
1-3	14220	COLOUR CAMERA
1	4946	MAXI VISION® ADAPTOR CABLE (1 PER CAMERA)
1	3876	RED/REG 9-32V IN 12V 2A OUT
1	5593	EXTENSION LOOM 70FT / 20M (1 PER CAMERA)

5" COLOUR CAMERA KIT - LIGHT VEHICLES



9391 pictured

- 1 x Camera kit - **Part No 9391**

Kit includes:

1	9299	5" MONITOR LCD
1	11858	COLOUR CAMERA IP68 CCD HAD II (SMALL)
1	8420	LIGHT DUTY FAN MOUNT

7" CAMERA KITS

7" COLOUR CAMERA KIT - COMMERCIAL VEHICLE



- 1 x Camera kit - **Part No 11931**
- 2 x Camera kit - **Part No 11932**
- 3 x Camera kit - **Part No 11933**
- 4 x Camera kit - **Part No 11934**

Kit includes:

1	11926	7" MONITOR LCD
1-4	11858	COLOUR CAMERA (SMALL)
1	11945	4 CAMERA INPUT LOOM TO SUIT 11926 MONITOR

7" BLACK & WHITE CAMERA KIT - STANDARD CAMERA



- 1 x Camera kit - **Part No 4271**
- 2 x Camera kit - **Part No 4272**
- 3 x Camera kit - **Part No 8810**
- 4 x Camera kit - **Part No 8811**

Kit includes:

1	11939	7" MONITOR LCD
1-4	0683	BLACK & WHITE CAMERA
1	11927/11928/ 11929/11930	1/2/3/4 CAMERA INPUT LOOM TO SUIT 11939 MONITOR

7" COLOUR CAMERA KIT - STANDARD CAMERA



- 1 x Camera kit - **Part No 4218**
- 2 x Camera kit - **Part No 4219**
- 3 x Camera kit - **Part No 4108**
- 4 x Camera kit - **Part No 8816**

Kit includes:

1	11939	7" MONITOR LCD
1-4	11857	COLOUR CAMERA
1	11927/11928/ 11929/11930	1/2/3/4 CAMERA INPUT LOOM TO SUIT 11939 MONITOR

7" COLOUR CAMERA KIT - HEAVY DUTY CAMERA



- 1 x Camera kit - **Part No 11691**
- 2 x Camera kit - **Part No 11692**
- 3 x Camera kit - **Part No 11694**
- 4 x Camera kit - **Part No 11695**

Kit includes:

1	11939	7" MONITOR LCD
1-4	14220	COLOUR CAMERA
1	11927/11928/ 11929/11930	1/2/3/4 CAMERA INPUT LOOM TO SUIT 11939 MONITOR
1	4946	MAXI VISION® ADAPTOR CABLE (1 PER CAMERA)
1	5593	EXTENSION LOOM 70FT / 20M (1 PER CAMERA)

7" COLOUR CAMERA KIT - DUAL VIEW



- 1 x Camera kit - **Part No 14391**

Kit includes:

1	11926	7" MONITOR LCD
1	14348	CAMERA 1.3M MULTI VIEW
1	11942	1 CAMERA INPUT LOOM

10.4" CAMERA KITS

10.4" COLOUR CAMERA KIT - STANDARD CAMERA



ADD UP TO
4X
CAMERAS

- 1 x Camera kit - **Part No 6221**
- 2 x Camera kit - **Part No 7746**
- 3 x Camera kit - **Part No 10965**
- 4 x Camera kit - **Part No 10966**

Kit includes:

1	11935	10.4" MONITOR LCD
1-4	11857	COLOUR CAMERA
1	3876	RED/REG 9-32V IN 12V 2A OUT
1	6838	SPLITTER BOX
1	2880	ADAPTOR LOOM RCA MALE TO RCA MALE 1.5 METRES
1	11976	SOCKET RAM DOUBLE ARM 8"
1	11979	BASE RAM 2" X 4" BALL SIZE C
1	11977	BASE RAM 75X75MM VESA SIZE C
1	13066	RAM VESA MOUNT MOUNTING HOLE

10.4" COLOUR CAMERA KIT - HEAVY DUTY CAMERA



ADD UP TO
4X
CAMERAS

HD

- 1 x Camera kit - **Part No 11696**
- 2 x Camera kit - **Part No 11697**
- 3 x Camera kit - **Part No 11698**
- 4 x Camera kit - **Part No 11699**

Kit includes:

1	11935	10.4" MONITOR LCD
1-4	14220	COLOUR CAMERA
1	3876	RED/REG 9-32V IN 12V 2A OUT
1	6838	SPLITTER BOX
1	2880	ADAPTOR LOOM RCA MALE TO RCA MALE 1.5 METRES
1	4946	MAXI VISION® ADAPTOR CABLE (1 PER CAMERA)
1	5593	EXTENSION LOOM 70FT / 20M (1 PER CAMERA)
1	5893	MONITOR MOUNT

15" CAMERA KITS

15" COLOUR CAMERA KIT - STANDARD CAMERA



- 1 x Camera kit - **Part No 10967**
- 2 x Camera kit - **Part No 10968**
- 3 x Camera kit - **Part No 10969**
- 4 x Camera kit - **Part No 10970**

Kit includes:

1	12891	15" MONITOR LCD
1-4	11857	COLOUR CAMERA
1	3876	RED/REG 9-32V IN 12V 2A OUT
1	6838	SPLITTER BOX
1	2880	ADAPTOR LOOM RCA MALE TO RCA MALE 1.5 METRES
1	10973	RAM ARM 8" 2.25" BALL
1	10972	RAM BASE 2" X 3" 2.25" BALL
1	10971	RAM BASE 75X75MM VESA MOUNT

15" COLOUR CAMERA KIT - HEAVY DUTY CAMERA



- 1 x Camera kit - **Part No 11701**
- 2 x Camera kit - **Part No 11702**
- 3 x Camera kit - **Part No 11703**
- 4 x Camera kit - **Part No 11704**

Kit includes:

1	12891	15" MONITOR LCD
1-4	14220	COLOUR CAMERA
1	3876	RED/REG 9-32V IN 12V 2A OUT
1	6838	SPLITTER BOX
1	2880	ADAPTOR LOOM RCA MALE TO RCA MALE 1.5 METRES
1	4946	MAXI VISION® ADAPTOR CABLE (1 PER CAMERA)
1	5593	EXTENSION LOOM 70FT / 20M (1 PER CAMERA)
1	10973	RAM ARM 8" 2.25" BALL
1	10972	RAM BASE 2" X 3" 2.25" BALL
1	10971	RAM BASE 75X75MM VESA MOUNT

27" CAMERA KITS

27" COLOUR CAMERA KIT - HEAVY DUTY CAMERA



- 1 x Camera kit - **Part No 11705**
- 2 x Camera kit - **Part No 11706**
- 3 x Camera kit - **Part No 11707**
- 4 x Camera kit - **Part No 11708**

Kit includes:

1	12772	27" MONITOR LCD
1-4	14220	COLOUR CAMERA
1	3876	RED/REG 9-32V IN 12V 2A OUT
1	6838	SPLITTER BOX
1	2880	ADAPTOR LOOM RCA MALE TO RCA MALE 1.5 METRES
1	4946	MAXI VISION® ADAPTOR CABLE (1 PER CAMERA)
1	5593	EXTENSION LOOM 70FT / 20M (1 PER CAMERA)
1	10973	RAM ARM 8" 2.25" BALL
1	10972	RAM BASE 2" X 3" 2.25" BALL
1	10971	RAM BASE 75X75MM VESA MOUNT

DVR CAMERA KITS

The Maxi Vision® Digital Video Recorder (DVR) is robust in design and ideally suited to industrial and mining applications. Housed in an aluminium casing this recorder is designed to stand up to the harshest of environments.

This multi-voltage unit comes complete with heavy duty Solid State Drive (SSD), GPS antenna, remote control and four camera input.

View all recorded images on screen (four camera view including displayed GPS co-ordinates and GPS speed indicator).

Images are easily downloaded by the Maxi Vision® PC Viewer showing over speed, events, driving route, speed, time, location and GPS tracking via Google map interface (terrain or map display available).

This all-in-one unit is your solution for driver management, events recording, machine monitoring and training.

5" COLOUR DVR CAMERA KIT - HEAVY DUTY CAMERA



- 1 x Camera kit - Part No 11713
- 2 x Camera kit - Part No 11714
- 3 x Camera kit - Part No 11715

Kit includes:

1	9299	5" MONITOR LCD
1-3	14220	COLOUR CAMERA
1	14318	RECORDER DVR 4CH SSD 12/24V
1	4946	MAXI VISION® ADAPTOR CABLE (1 PER CAMERA)
1	3876	RED/REG 9-32V IN 12V 2A OUT
1	5593	EXTENSION LOOM 70FT / 20M (1 PER CAMERA)
1	2880	ADAPTOR LOOM RCA MALE TO RCA MALE 1.5 METRES
1	8093	ADAPTOR CABLE MINI DIN TO RCA

7" COLOUR DVR CAMERA KIT - STANDARD CAMERA



- 1 x Camera kit - Part No 10948
- 2 x Camera kit - Part No 10949
- 3 x Camera kit - Part No 10950
- 4 x Camera kit - Part No 10951

Kit includes:

1	11939	7" MONITOR LCD
1-4	11857	COLOUR CAMERA
1	14318	RECORDER DVR 4CH SSD 12/24V
1	4946	MAXI VISION® ADAPTOR CABLE (1 PER CAMERA)
1	11927/11928/ 11929/11930	1/2/3/4 CAMERA INPUT LOOM TO SUIT 11939 MONITOR
1	2880	ADAPTOR LOOM RCA MALE TO RCA MALE 1.5 METRES
1	8093	ADAPTOR CABLE MINI DIN TO RCA

7" COLOUR DVR CAMERA KIT - HEAVY DUTY CAMERA



- 1 x Camera kit - Part No 11709
- 2 x Camera kit - Part No 11710
- 3 x Camera kit - Part No 11711
- 4 x Camera kit - Part No 11712

Kit includes:

1	11939	7" MONITOR LCD
1-4	14220	COLOUR CAMERA
1	14318	RECORDER DVR 4CH SSD 12/24V
1	11927/11928/ 11929/11930	1/2/3/4 CAMERA INPUT LOOM TO SUIT 11939 MONITOR
1	2880	ADAPTOR LOOM RCA MALE TO RCA MALE 1.5 METRES
1	8093	ADAPTOR CABLE MINI DIN TO RCA

10.4" COLOUR DVR CAMERA KIT - STANDARD CAMERA



- 1 x Camera kit - **Part No 10954**
- 2 x Camera kit - **Part No 10955**
- 3 x Camera kit - **Part No 10956**
- 4 x Camera kit - **Part No 10957**

Kit includes:

1	11935	10.4" MONITOR LCD
1-4	11857	COLOUR CAMERA
1	14318	RECORDER DVR 4CH SSD 12/24V
1	3876	RED/REG 9-32V IN 12V 2A OUT
1	2880	ADAPTOR LOOM RCA MALE TO RCA MALE 1.5 METRES
1	5893	MONITOR MOUNT

10.4" COLOUR DVR CAMERA KIT - HEAVY DUTY CAMERA



- 1 x Camera kit - **Part No 11717**
- 2 x Camera kit - **Part No 11718**
- 3 x Camera kit - **Part No 11719**
- 4 x Camera kit - **Part No 11720**

Kit includes:

1	11935	10.4" MONITOR LCD
1-4	14220	COLOUR CAMERA
1	14318	RECORDER DVR 4CH SSD 12/24V
1	3876	RED/REG 9-32V IN 12V 2A OUT
1	6838	SPLITTER BOX
1	2880	ADAPTOR LOOM RCA MALE TO RCA MALE 1.5 METRES
1	4946	MAXI VISION® ADAPTOR CABLE (1 PER CAMERA)
1	5593	EXTENSION LOOM 70FT / 20M (1 PER CAMERA)
1	5893	MONITOR MOUNT

15" COLOUR DVR CAMERA KIT - HEAVY DUTY CAMERA



- 1 x Camera kit - **Part No 11721**
- 2 x Camera kit - **Part No 11722**
- 3 x Camera kit - **Part No 11723**
- 4 x Camera kit - **Part No 11724**

Kit includes:

1	12891	15" MONITOR LCD
1-4	14220	COLOUR CAMERA
1	14318	RECORDER DVR 4CH SSD 12/24V
1	3876	RED/REG 9-32V IN 12V 2A OUT
1	6838	SPLITTER BOX
1	2880	ADAPTOR LOOM RCA MALE TO RCA MALE 1.5 METRES
1	4946	MAXI VISION® ADAPTOR CABLE (1 PER CAMERA)
1	5593	EXTENSION LOOM 70FT / 20M (1 PER CAMERA)
1	10973	RAM ARM 8" 2.25" BALL
1	10972	RAM BASE 2" X 3" 2.25" BALL
1	10971	RAM BASE 75X75MM VESA MOUNT

27" COLOUR DVR CAMERA KIT - HEAVY DUTY CAMERA



- 1 x Camera kit - **Part No 11725**
- 2 x Camera kit - **Part No 11726**
- 3 x Camera kit - **Part No 11727**
- 4 x Camera kit - **Part No 11728**

Kit includes:

1	12772	27" MONITOR LCD
1-4	14220	COLOUR CAMERA
1	14318	RECORDER DVR 4CH SSD 12/24V
1	3876	RED/REG 9-32V IN 12V 2A OUT
1	6838	SPLITTER BOX
1	2880	ADAPTOR LOOM RCA MALE TO RCA MALE 1.5 METRES
1	4946	MAXI VISION® ADAPTOR CABLE (1 PER CAMERA)
1	5593	EXTENSION LOOM 70FT / 20M (1 PER CAMERA)
1	10973	RAM ARM 8" 2.25" BALL
1	10972	RAM BASE 2" X 3" 2.25" BALL
1	10971	RAM BASE 75X75MM VESA MOUNT

FORKLIFT CAMERA SYSTEMS

Maxi Vision® Camera systems offer operators a new perspective on driving and operating their equipment. The camera systems are designed to enhance safety by improving the operator's vision when performing such tasks as lifting, transporting loads or reversing. The systems are suitable for use on small or large forklift trucks, battery or internal combustion models.

The Maxi Vision® range of colour LCD monitor and camera options are robust in design and are ideally suited to industrial equipment. Heavy duty casing and mounting options are also available to suit custom applications.

The camera system includes pulleys, heavy duty cabling, special mounting and fittings to enable reliable installation to most electrical and Internal Combustion forklifts.



7" FORKLIFT MAST CAMERA KIT



Camera kit - Part No 6660

Kit includes:

1	8030	7" MONITOR LCD
1	11858	CAMERA COLOUR IP68 CCD HAD II
1	7352	PULLEY KIT
1	6560	MAST CAMERA ADAPTOR LOOM
1	6559	CAMERA LOOM 15M
1	6554	INSULATED MOUNT
1	6623	CABLE GRIP KIT
1	9344	MOUNT KIT T/S FORKLIFT MONITOR

7" FORKLIFT MAST CAMERA KIT - 3 STAGE MAST CLOSED CAB



Camera kit - Part No 12576

Kit includes:

1	11931	7" - 1 COLOUR CAMERA CAMERA KIT
1	6554	MOUNTING KIT
1	9344	MOUNT KIT T/S FORKLIFT MONITOR
1	6560	ADAPTOR LOOM FORK FRONT CAMERA
1	6559	CAMERA LOOM 15M
1	6623	CABLE GRIP KIT
1	7352	PULLEY KIT

CAMERA SYSTEM TYPICAL LAYOUTS

5" MONITOR SYSTEM LAYOUT

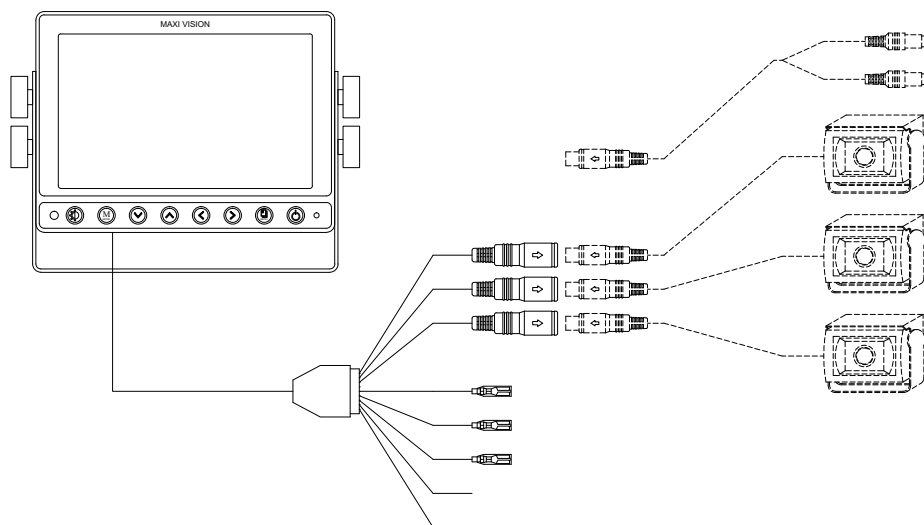

7" MONITOR SYSTEM LAYOUT

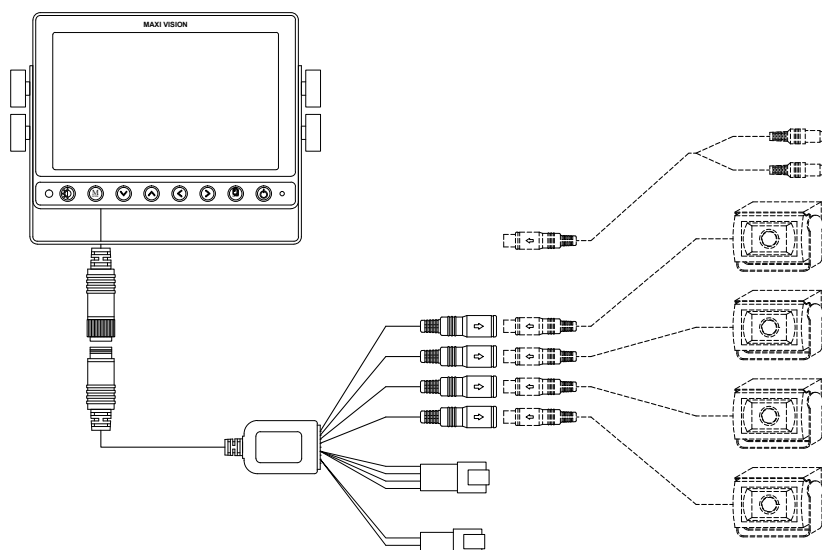

10.4" MONITOR SYSTEM LAYOUT

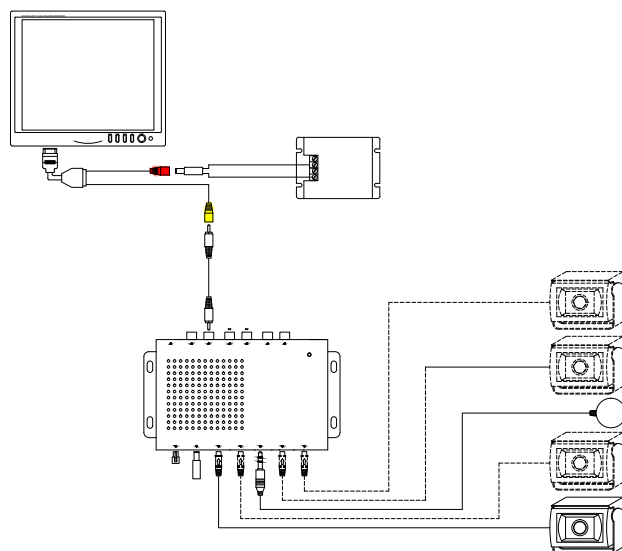

CAMERA SYSTEM WITH DVR TYPICAL LAYOUTS

7" MONITOR SYSTEM WITH DVR LAYOUT

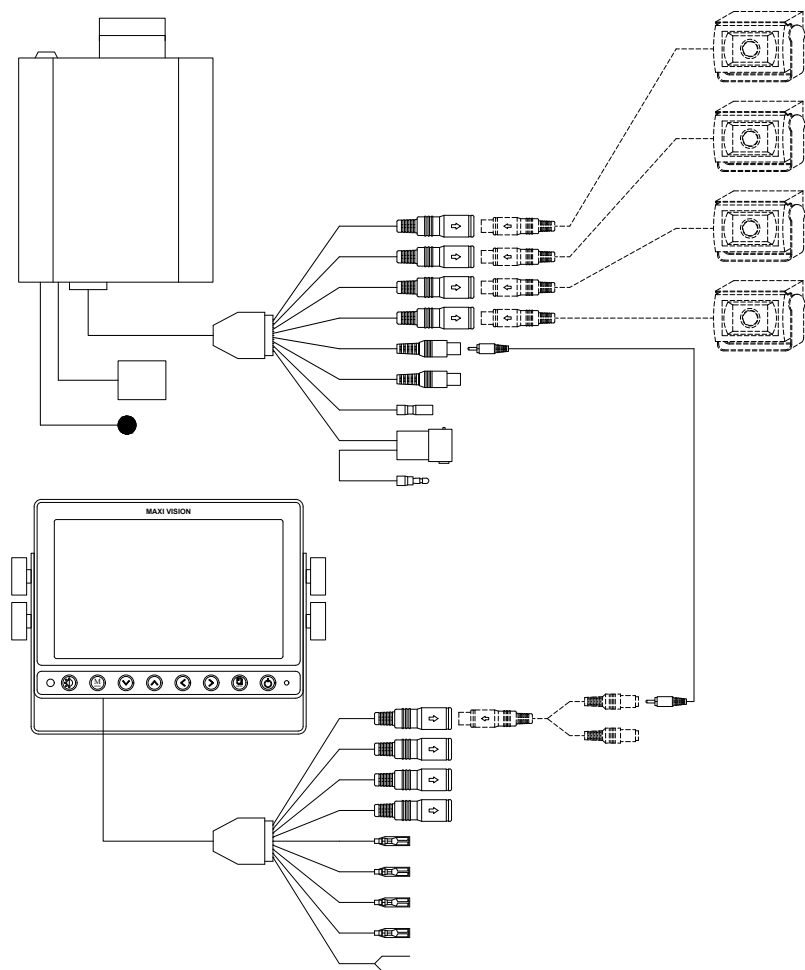

10.4", 15" & 27" MONITOR SYSTEM WITH DVR LAYOUT

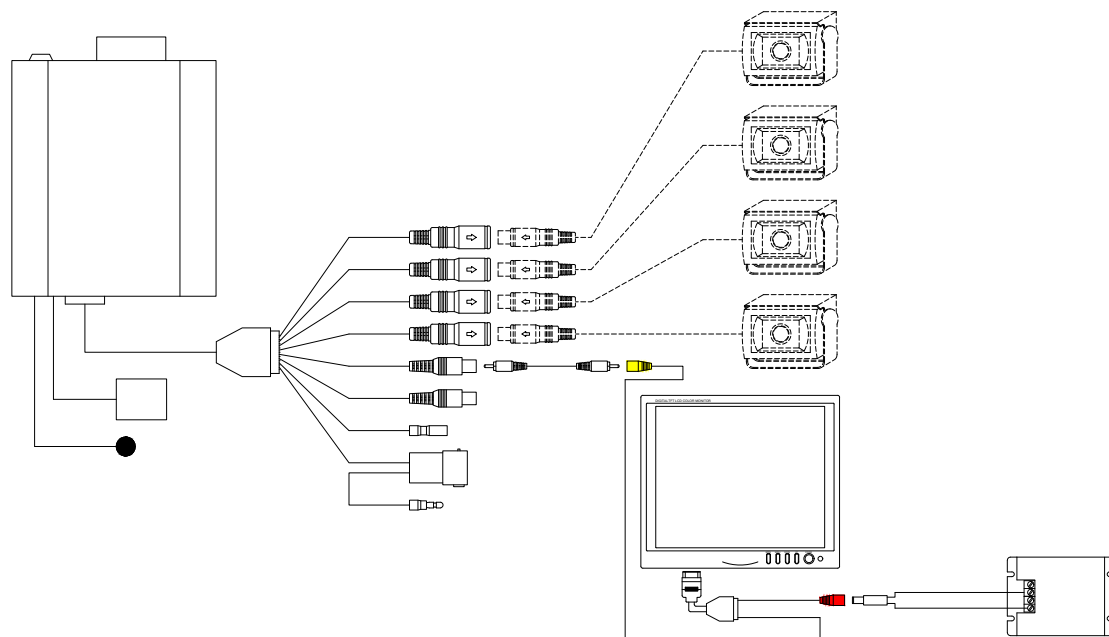



Proven in surface
and underground
mining applications





Discover more: rct-global.com

sales@rct-global.com

AUSTRALIA:	+61 8 9353 6577
AFRICA:	+27 83 292 4246
CANADA:	+1 705 590 4001
RUSSIA / CIS:	+7 910 411 1174
SOUTH AMERICA:	+56 3 5229 9409
USA:	+1 801 938 9214

